



Vacuum-Stonemagnet

SM

002



**1 Contents**

<b>1</b>	<b>Contents</b> .....	<b>2</b>
<b>2</b>	<b>Declaration of conformity</b> .....	<b>4</b>
<b>3</b>	<b>General</b> .....	<b>9</b>
3.1	Authorized inset.....	9
3.1.1	Emissions.....	9
3.2	Safety symbols .....	9
3.3	Definition skilled worker / specialist.....	10
3.4	Safety Marking .....	10
<b>4</b>	<b>Description</b> .....	<b>11</b>
3.1	Components of the Vacuum Lifting Device .....	11
4.1	Controls .....	12
4.1.1	On/Off switch (3 positions).....	12
4.1.2	Manual slide valve .....	12
4.1.3	Vacuum pumps .....	12
4.1.4	Suction plates .....	12
<b>5</b>	<b>Technical Data</b> .....	<b>13</b>
5.1	Miscellaneous .....	13
<b>6</b>	<b>Safety</b> .....	<b>14</b>
6.1	Personal safety requirements.....	14
6.2	Protective equipment .....	14
6.3	General.....	14
6.4	Safety at work.....	14
6.5	Requirements for the Installation Location .....	15
6.6	Special Hazards .....	15
6.7	Workplaces .....	16
6.8	Behaviour in Emergencies.....	16
6.9	Testing the Safety Devices.....	16
6.9.1	Testing the vacuum gauge .....	16
6.9.2	Testing the red flashing lamp .....	16

6.9.3	Inspecting the vacuum hoses and hose clamps .....	17
6.9.4	Testing the vacuum reservoir .....	17
6.9.5	Hydraulic excavator and other lifting equipment.....	17
<b>7</b>	<b>Installation.....</b>	<b>18</b>
7.1	Commissioning .....	18
7.2	Mounting the suction plate on the vacuum lifting device.....	18
<b>8</b>	<b>Operation .....</b>	<b>19</b>
8.1	General.....	19
8.2	Lifting Loads.....	19
8.3	Lowering Loads .....	19
<b>9</b>	<b>Maintenance and care .....</b>	<b>20</b>
9.1	Maintenance.....	20
9.2	General Notes.....	20
9.3	Maintenance Plan.....	21
9.4	Suction Plates and Sealing Lips .....	21
9.5	Filter.....	22
9.6	Draining Condensation .....	22
9.7	Changing the Battery .....	23
9.8	Repairs .....	23
9.9	Troubleshooting.....	24
9.10	Safety procedures.....	25

## **2 Declaration of conformity**

**Konformitätserklärung; Declaration of conformity ; Déclaration de Conformité;  
Certificato di conformità norme CE; Declaración de conformidad**

**DESCRIPTION:** Vacuum-Stonemagnet  
SM

Hersteller: **PROBST GREIFTECHNIK VERLEGESYSTEME**

Manufacturer: Gottlieb-Daimlerstraße 6  
Producteur: 71729 Erdmannhausen  
Costruttore: Probst Greiftechnik Verlegesysteme GmbH  
Fabricante: info@probst-gmbh.de www.probst-gmbh.de

### **Einschlägige Bestimmungen, denen die Maschine entspricht:**

Complies with the following provisions applying to it:

Spécifications respective qui sont conformes à la machine:

Definizione che sono conformi alla macchina:

Cumple con las siguientes provisiones aplicables a:

#### **98/392/EWG (Maschinenrichtlinie)**

98/392/EWG (EC-machinery directive)

98/392/EWG (Idée directrice EC)

98/392/EWG (EG-Linea di Guida CE)

98/392/EWG (Directrices de la CE)

#### **73/23/EWG (Niederspannungsrichtlinie)**

73/23/EWG (Low voltage standard)

73/23/EWG (Directive basse tension)

73/23/EWG (Basso voltaggio standard)

73/23/EWG (Voltaje de baja tensión común)

#### **89/336/EWG (Elektromagnetische Verträglichkeit)**

89/336/EWG (Electromagnetic compatibility)

89/336/EWG (Electromagnétique Compatibilité)

89/336/EWG (Compatibilità elettromagnetica)

89/336/EWG (Compatibilidad electromagnética)

### **Fundstellen der harmonisierten Normen:**

Applied harmonized standards in particular:

Lieux de découverte des normes harmonisées:

Luogo di accertamento delle norme armonizzate

Aplicados en particular los siguientes estándares

**DIN EN 292-1**

**11.91**

**Sicherheit von Maschinen, Grundbegriffe, allgemeine  
Gestaltungsleitsätze, Teil 1: Grundsätzliche Terminologie,  
Methodik.**

Safety of machinery; Basic concepts, general principles for design,  
Part 1: Basic terminology, methodology.

Sécurité des machines; notions fondamentales, principes  
généraux de conception, Partie 1: terminologie de base,  
méthodologie.

Sicurezza della macchina, nozioni fondamentali, verifica della  
struttura generale, Parte 1: terminologia di base, metodologia.

Seguridad de la maquinaria; conceptos básicos, principios  
generales de diseño, parte 1: terminología básica, metodología.

<b>DIN EN 292-2</b>	<b>11.91</b>	<b>Sicherheit von Maschinen, Grundbegriffe, allgemeine Gestaltungsleitsätze, Teil 2: Technische Leitsätze und Spezifikationen.</b> Safety of machinery; basic concepts, general principles for design; Part 2: principles and specifications. Sécurité des machines; notions fondamentales, principes généraux de conception; Partie 2: Principes et spécifications techniques. Sicurezza della macchina, nozioni fondamentali, verifica della struttura generale; Parte 2: principi e specificazioni tecniche. Seguridad de la maquinaria; conceptos básicos, principios generales de diseño, parte 2: principios y especificaciones.
<b>DIN EN 294</b>	<b>08.92</b>	<b>Sicherheitsabstände gegen das Erreichen von Gefahrenstellen mit den oberen Gliedmaßen.</b> Safety distance against reaching hazard places with the upper extremities. Distances de sécurité afin de pas atteindre le lieux de danger avec les extrémités du corps supérieurs. Distanza di sicurezza al fine di evitare pericolo di passaggio sotto carichi sospesi. Distancia de seguridad con el fin de evitar que las extremidades superiores del cuerpo alcancen las zonas de peligro.
<b>DIN EN 349</b>	<b>06.93</b>	<b>Mindestabstände zur Vermeidung des Quetschens von Körperteilen.</b> Minimum distance to avoid squeezing any parts of the body. Distances minimum afin d'éviter une contusion des parties du corps. Distanza minima al fine di evitare contusioni di parti del corpo. Distancia mínima con el fin de evitar contusiones en cualquier parte del cuerpo.
<b>DIN EN 60204-1</b>	<b>01.93</b>	<b>Sicherheit von Maschinen, Elektrische Ausrüstung von Industriemaschinen</b> Safety of machinery, electrical equipment of industrial machines. Sûreté de machines, équipement électrique de machines industrielles. Sicurezza della macchina, impianto elettrico a norme Seguridad de máquinas, equipos eléctricos de máquinas industriales.

DIN EN 55014-1 09.97

**Elektromagnetische Verträglichkeit –Anforderungen an Haushaltsgeräte, Elektrowerkzeuge u. ähnliche Elektrogeräte. Teil 1: Störaussendung**

Electromagnetic compatibility – Requirements for household appliances, electric tools, and similar apparatus.  
Part 1: Emission.

Exigences de compatibilité électromagnétique vis-à-vis des appareils ménagers, outils électriques et appareils électriques semblables.  
Partie 1: émission de brouillage

Compatibilità elettromagnetica – Requisiti per l'alloggiamento degli accessori,utensili elettrici e attrezzi simili.  
Parte 1 : Emissioni

Compatibilidad electromagnética-Requisitos a aparatos electrodomésticos, Herramientas eléctricas y aparatos eléctricos similares. Parte 1: Señal de fallos.

DIN EN 55014-2 10.97

**Elektromagnetische Verträglichkeit –Anforderungen an Haushaltsgeräte, Elektrowerkzeuge u. ähnliche Elektrogeräte. Teil 2: Störfestigkeit.**

Electromagnetic compatibility – Requirements for household appliances, electric tools, and similar apparatus.  
Part 2: Immunity.

Exigences de compatibilité électromagnétique vis-à-vis des appareils ménagers, outils électriques et appareils électriques semblables.  
Partie 2: immunité de brouillage

Compatibilità elettromagnetica- Requisiti per l'alloggiamento Degli accessori,utensili elettrici e attrezzi simili.  
Parte 2: Immunità

Compatibilidad electromagnética-Requisitos a aparatos electrodomésticos, Herramientas eléctricas y aparatos eléctricos similares. Parte 2: Inmunidad en contra de interferencias.

DIN EN 1012-1 07.96  
DIN EN 1012-2 07.96

**Kompressoren und Vakuumpumpen; Sicherheitsanforderungen Teil 1 und 2.**

Compressors and vacuum pumps; Safety requirements part 1 and 2.

Compresseurs et pompes a vide; Exigences en matière de sécurité  
Partie 1 et 2.

Compressori e pompe vacuum .Requisiti di sicurezza parte 1 e 2.

Compresores y bombas de vacio; requisitos de seguridad  
Parte 1 y 2.

**Fundstellen nationaler technischer Normen und Spezifikationen:**

Applied national technical standards and specifications in particular:  
Lieux de découverte des normes et spécification techniques nationales:  
Origine delle norme e specificazioni tecniche:  
Aplicados en particular los siguientes estándares:

<b>DIN 8563</b> <b>T1 + T2</b>	<b>10.78</b>	<b>Sicherung der Güte von Schweißarbeiten.</b> Securing the quality of welding works. Sécurité de la qualité des travaux à souder. Sicurezza di buona tenuta della saldatura. Seguridad de la calidad de la soldadura.
<b>DIN 15428</b>	<b>08.78</b>	<b>Hebezeug Lastaufnahmeeinrichtungen , Technische Lieferbedingungen.</b> Lifting machines, technical delivery terms. Installations pour pendre des charges des appareils de levage, conditions de livraison techniques. Verifica del carico accettato dall' impianto di sollevamento, capitolato tecniche. Elevación de la maquinaria, términos técnicos de entrega.
<b>DIN 31001</b>	<b>04.83</b>	<b>Sicherheitsgerechtes Gestalten technischer Erzeugnisse; Schutzeinrichtungen, Begriffe, Sicherheitsabstände für Erwachsene und Kinder.</b> Safety requirements for the design of technical equipment; protecting devices, definitions, safety distances for adults and children. Formation des produits techniques, installation de protection, notions, distances de sécurité pour des adultes et des enfants, conformes à la sécurité. Conoscenza delle norme di sicurezza da parte dell' utilizzatore, protezioni antinfortunistiche, distanza di sicurezza dei carichi sospesi da adulti e bambini. Requisitos de seguridad para el diseño del equipo técnico; dispositivos de protección, nociones, distancias de seguridad para adultos y niños.
<b>DIN 45625</b>	<b>02.77</b>	<b>Luftschallmessung, Hüllflächen-Verfahren; Verdichter einschl. Vakuumpumpen (Verdränger-, Turbo- und Strahlverdichter).</b> Airborne noise measurement; enveloping surface-procedure; compressor including vacuum pump (displacement-, turbo- and jet-compressors).

Repérage au son aérien, Méthode de surface couverte;  
Compresseur y compris Pompes à vide (Compresseur à  
suppression, à turbo et à jet).

Misurazioni del suono acustico, compressore annesso alla Pompa  
del vacuu. (dislocazione-,turbo e jet compressori)

Medición del sonido aéropropagado, procedimiento de superficies  
envolventescompresor incluyendo bombas de vacío (compresor  
de expulsión, de turbo, de reacción)

**DIN 45635-13**

**02.77**

**Geräuschemessung an Maschinen  
(Verdränger-, Turbo- und Strahlverdichter).**

Measurement of airborne noise emitted by machines  
(displacement-, turbo- and jet-compressors).

Mesure sonore sur les machines  
(compresseur volumétrique, centrifuge et faisceau).

Misurazioni del livello di rumorosità emesso dalle macchine  
(dislocazione-,turbo-e jet compressori)

Medición de ruidos en maquinaria  
(Expulsadores-Turbos y Compresores de metal).

**Signature:**

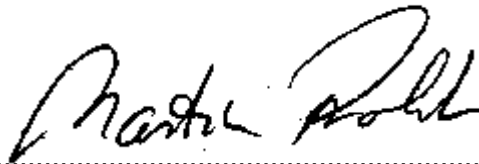

Erdmannhausen, 16.04.2004.....

(M. Probst, Managing director)



### 3 General



Prohibition

- The device is only designed for the use specified in this documentation.
- Every other use is not authorized and is forbidden!
- All relevant safety regulations, especially regulations of the declaration of conformity, and additional local health and safety regulations have to be observed.

#### 3.1 Authorized inset

The vacuum lifting device (Stone Magnet-SM) is intended for lifting, transporting and laying non-porous stone slabs, concrete elements, steps, stoneware pipes, etc. The loads may be lifted only a short distance from the ground.



Prohibition

**The maximum lifting capacity of 200 kg or 400 kg may not be exceeded.**

Some of the suction plates which can be mounted on the vacuum lifting device reduce the lifting capacity of the device. The maximum load is specified on each suction plate and may never be exceeded.

The vacuum lifting device (SM) may be used only suspended vertically from a crane or other lifting tackle in conjunction with a lifting device (such as excavator or truck loader crane).

##### 3.1.1 Emissions

The continuous sound pressure level generated by the unit is less than 75 dB(A).



Prohibition

Transport of persons and animals with the load or the vacuum lifting device (SM) itself is forbidden!

Unauthorised modification of the vacuum lifting device (SM) is forbidden for safety reasons!



**The operating, maintenance and servicing instructions in this manual must be observed.**

#### 3.2 Safety symbols

 <b>Danger</b>	<p><b><i><u>Danger to life!</u></i></b>            Identifies imminent hazard. If you do not avoid the hazard, death or severe injury will result.</p>
 <b>Attention</b>	<p><b><i><u>Hazardous situation!</u></i></b>            Identifies a potentially hazardous situation. If you do not avoid the situation, injury or damage to property can result.</p>
 <b>Prohibition</b>	<p><b><i><u>Prohibition!</u></i></b>            Identifies imminent a prohibition. If you do not avoid the prohibition, death and severe injury, or damage to property will result.</p>

### 3.3 Definition skilled worker / specialist

Only skilled workers or specialists is it allowed to carry out the installation,- maintenance, - and repair work on these device!

Skilled workers or specialists must have for the following points (if it applies for these device), the necessary professional knowledge.

- for mechanic
- for hydraulics
- for pneumatics
- for electricians

### 3.4 Safety Marking

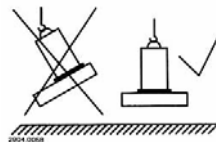
WARNING SIGN		
Symbol	Meaning	Order-No.:
	It is not allowed to be under hanging loads. <b>Danger to life!</b>	2904.0101
	Do not lift any components off-centre.	2904.0058

**4 Description**

**3.1 Components of the Vacuum Lifting Device**

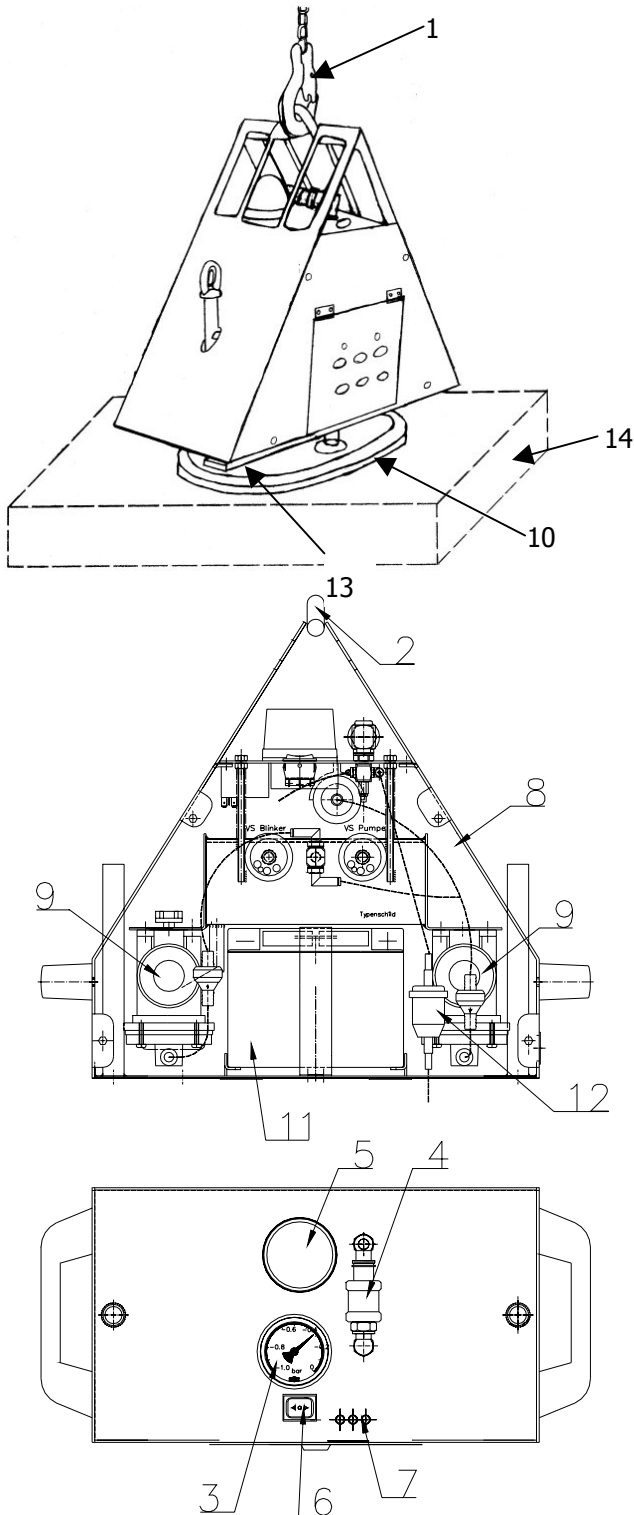

Pos.	Description
1	Crane hook (not included)
2	Lifting eye
3	Vacuum gauge
4	Manual slide valve
5	Red flashing lamp
6	On/Off switch (3 positions)
7	LED indicators for battery charge
8	Housing with vacuum reservoir
9	Vacuum pumps
10	Suction plate (not included)
11	Battery
12	Dirt filter
13	C-rail of suction pad (not included)
14	Stone slab

## **4.1 Controls**

### **4.1.1 On/Off switch (3 positions)**

**Position 0:**

- Vacuum pumps switched off.

**Position 1:**

- One vacuum pump active: power-saving mode for non-porous loads.

**Position 2:**

Both vacuum pumps active: for lifting porous loads or for faster vacuum generation.

### **4.1.2 Manual slide valve**

For gripping and releasing the load:

- move away from the flashing lamp to grip and hold the load;
- move towards the flashing lamp to release the load.

### **4.1.3 Vacuum pumps**

- The vacuum pumps generate the vacuum for the vacuum lifting device (SM).
- They are provided with power by a rechargeable and replaceable 12 V battery.
- Three LEDs indicate the state of charge of the battery:  
red = battery fully discharged / green = battery OK / yellow = battery overcharged.
- For improved safety, there is a vacuum switch installed in the lifting device SM.
- If the vacuum drops to -0.53 bar, the vacuum pumps are automatically switched on again until the vacuum reaches -0.66 bar.

### **4.1.4 Suction plates**

- The various suction plates apply the vacuum to the load. They permit lifting, transport and positioning of various objects (see "Use for the Intended Purpose").
- Use only suction plates which are approved for the vacuum lifting device (SM).
- Never exceed the maximum lifting capacity of the suction plates.

## 5 Technical Data

	Switch position 1 1 pump active	Switch position 2 2 pumps active
Maximum lifting capacity*	200 kg/400 kg (SPS200/400) **	200 kg/400 kg (SPS200/400) **
Intrinsic weight (without suction plate)	approx. 30 kg	approx. 30 kg
Volume of vacuum reservoir	approx. 2 l	approx. 2 l
Suction capacity of the vacuum pump	29 l/min	58 l/min
Maximum vacuum	700 mbar	700 mbar
Operating temperature	-20 °C to 40 °C	-20 °C to 40 °C
Supply voltage	12 V DC	12 VDC
Current consumption	3.8 A	7.6 A
Temperature	max. 40 °C	max. 40 °C
Ambient temperature	20 °C	20 °C
Pumped medium	air	air

\* The maximum lifting capacity applies with a vacuum of -0.46 bar with all suction plates in contact with the load.

\*\* SPS 200/SPS 400 =Suction plate 200 kg and suction plate 400 kg

### 5.1 Miscellaneous

- Suction plate SPS 200 / lifting capacity 200 kg / 280 mm x 470 mm.
- Suction plate SPS 400 / lifting capacity 400 kg / 350 mm x 750 mm.
- Special suction plates available to order (e.g. for stoneware pipes).
- Quick-change system for suction plates.
- Crossbeam TRA-SM for mounting multiple suction plates available to order.
- Rechargeable and replaceable 12 V battery.
- Red lamp flashes at a vacuum of 0-580 mbar.
- Automatic re-evacuation feature switches vacuum pumps on again when the vacuum drops to -0,53 bar.
- LED indicators show the state of charge of the battery: Red = battery empty / Green = battery OK / Yellow = battery overcharged.
- Non-return valve maintains vacuum if pump fails.
- Manual side valve for releasing the vacuum.
- Metal parts galvanised.
- Robust housing with integrated lifting eye for suspension from lifting tackle.

## 6 Safety

### 6.1 Personal safety requirements

- Only qualified, authorized certificated personal is allowed to operate the device and all devices which are connected (lifting equipment).



- Each operator must have read and understood the operating instructions.
- The manual guiding is only allowed for machines with handles.



### 6.2 Protective equipment

The protective equipment must consist, according to the safety regulations of the following parts:

- Protective clothing
- Safety gloves
- Safety shoes

### 6.3 General



- Before using the vacuum lifting device (SM) check the functions and the working condition.
- **Maintenance and lubrication are only permitted when vacuum lifting device (SM) is shut down!**
- **Do not use the vacuum lifting device (SM) device, until all faults which can cause safety hazards are removed.**
- **If there are splits at carrying parts of the vacuum lifting device (SM), immediately stop using it.**
- The operating instructions must be available at the workplace every time.
- Do not remove the data-plates of the machine.
- Unrecognisable data-plates must be replaced.

### 6.4 Safety at work



Danger





Prohibition



Prohibition





- The use of the vacuum lifting device (SM) is only permitted in proximity to the ground. Do not swing it over peoples heads.
- While using the vacuum lifting device (SM) is the stay of persons in the working area forbidden. Except it is indispensable. Caused of the way of using the vacuum lifting device (SM), e.g. if the device must be leaded by hand.
- While using the vacuum lifting device (SM) be sure that there are no persons in the working area. Danger to Life!!
- The operator is not allowed to leave the control unit as long as the vacuum lifting device (SM) loaded with load. The load must always be in the range of vision of the operator.
- The manual guiding of is only allowed for vacuum lifting devices with handles.

- Do not use the vacuum lifting device (SM) to jerk seized set down load.
-  **Prohibition**
- Do not lift any components off-centre, because that could fall down.
  - The vacuum lifting device (SM) should not be opened if the opening path of the gripping arm is blocked by a resistance (e.g. other concrete blocks or the like)!
-  **Prohibition**
- The capacity and the nominal width the vacuum lifting device (SM) are not allowed to cross over.
  - Avoid quick or jerky movements with the vacuum lifting device (SM). E.g. caused through driving fast over uneven grounds/site is forbidden. Because the gripping good could fall down.

## 6.5 Requirements for the Installation Location

-  **Prohibition**
- The lifting vacuum lifting device (SM) may not be used in explosion-risk rooms or areas.
  - The ambient temperature may not exceed and 40 °C (if this temperature is exceeded, please consult the manufacturer before using the device).
  - The vacuum lifting device (SM) must be connected to the electrical supply and the main switch of the crane from which it is suspended.  
Ensure, by means of internal instructions and regular inspections, that the area around the workplace is kept clean and tidy at all times.

## 6.6 Special Hazards

-  **Attention**
- The operating range have to be covered for unauthorized persons, especially children.
  - The workplace have to be sufficiently illuminated.
  - Take care handling wet, dirty and not solidified components.
  - The working with the vacuum lifting device (SM) in case of atmospheric editions under 37,5° F is forbidden!  
Because the goods could be fall down caused by dampness or freezing.
-  **Prohibition**
- Take care in case of thunderstorm!
  - Since the load is held on the suction plates of the unit by a vacuum, it will fall off as soon as this vacuum is lost.
  - This can happen if the vacuum generator fails. An integrated vacuum reservoir maintains the vacuum for a short safety period whose duration depends on the porosity of the workpiece surface.
-  **Danger**
- If the vacuum generator fails, lower the load immediately if this is possible. Otherwise, leave the danger area below the load immediately.
-  **Danger**
- The unit draws in large amounts of air and hair and items of clothing can be drawn into the air inlet. Do not look into the air inlet when the unit is running: it is even possible for your eyes to be drawn into the air inlet.

## 6.7 Workplaces

- The workplace of the operator is in front of the operator handle. The operator must stand so that he can see the vacuum gauge at all times.

## 6.8 Behaviour in Emergencies

An emergency situation exists when:

- power suddenly fails (unit switches off),
- the vacuum drops below -0.46 bar.
- In such cases, lower the load immediately if this is possible. Otherwise, leave the danger area below the load immediately. The load will be dropped from the lifting device!



## 6.9 Testing the Safety Devices

The vacuum lifting device (SM) is equipped with the following safety devices:

- vacuum gauge
- red flashing lamp



Test the safety devices at the beginning of each working shift (if the device is used intermittently) or once per week (if the device is used continually).

### 6.9.1 Testing the vacuum gauge

- Switch on the vacuum lifting device (SM).
- Place the vacuum lifting device (SM) on a sheet of metal or a similar airtight surface and apply the vacuum.
- **Caution:** only apply the vacuum. Do not lift the object, since it may be dropped during the test.
- Switch off the vacuum pump and observe the vacuum gauge. The vacuum may not drop by more than 0.1 bar per minute. If it drops faster than this, locate and rectify the fault before using the lifting device.



### 6.9.2 Testing the red flashing lamp

- Switch on the vacuum pump.
- The red lamp must flash until the vacuum reaches -0.58 bar and is then switched off automatically.
- Lift the edge of the rubber sealing lip with a screwdriver until the vacuum drops below -0,5 to -0,46 bar: the red lamp must start to flash again.



### 6.9.3 Inspecting the vacuum hoses and hose clamps

- Check that all vacuum hoses and hose clamps are securely seated. Tighten any loose connections.

### 6.9.4 Testing the vacuum reservoir



- See the sub-section "Leak test" in the section "Maintenance"
- Rectify any detected faults before using the lifting device. If a fault becomes apparent during, switch off the lifting device and rectify the fault.

### 6.9.5 Hydraulic excavator and other lifting equipment

- Hydraulic excavator and other lifting equipment has to be in good, safe working condition.
- **Take care that the maximum capacity of the hydraulic excavator and other lifting equipment is not exceeded.**
- Only authorized, certificated and qualified personnel is allowed to operate the lifting equipment / fork lift.
- The operator staff must have all the necessary qualifications.

## **7 Installation**

### **7.1 Commissioning**

The vacuum lifting device (SM) may be installed and maintained only by suitably qualified mechanics and electricians. Any work on the electrical components may be done only by qualified electricians.

- Place the lifting eye of the vacuum lifting device on the hook of the lifting tackle and secure it correctly. Note the dead weight of the lifting device and the maximum lifting capacity of the lifting tackle!
- Check the state of charge of the battery, as indicated by the three LED´s:  
Red = battery discharged  
Green = battery OK  
Yellow = battery overcharged

### **7.2 Mounting the suction plate on the vacuum lifting device**

#### **Switch off the lifting device before mounting a suction plate!**

- Insert the threaded rods of the T-shaped block into the two holes in the bottom of the housing and push the rods in until they project from the top of the housing.
- Screw the ring nuts on to the threaded rods (2-3 turns).
- The T-shaped block must be far enough away from the base of the housing to permit the C-rail of the suction block to be slid onto it from the side.
- Tighten the ring nuts and check that the suction plate is secure.
- Connect the vacuum hose to the suction plate.
- Before lifting any loads, check the safety devices of the lifting device.

#### **The suction plate can be changed as follows:**

- Switch off the vacuum lifting device (SM).
- Disconnect the vacuum hose.
- Loosen the ring nuts, holding the suction plate in position. Then slide off the suction plate.
- Mount the new suction plate on the lifting device as described above.

## 8 Operation

### 8.1 General

Before the vacuum lifting device is used by the operator, the following must be checked by a mechanic. Any faults which are detected must be rectified before the vacuum lifting device is used.

### 8.2 Lifting Loads

- Position the vacuum lifting device directly over the load. Avoid tilting the load during lifting. Ensure that the load is balanced.
- Place the vacuum lifting device on the load.
- Switch on the lifting device by moving the main switch to position 1 or 2, depending on the surface finish of the load and/or how fast the vacuum is to be established.
- Slide the sleeve of the manual slide valve away from the red lamp.
- The load is now sucked.
- Observe the vacuum gauge and the red lamp. When the vacuum reaches a value of -0.58 bar (the red lamp stops flashing), you can lift the load.  
**Never attempt to lift the load before this, since it will be dropped.**
- When lifting, ensure that only one piece is picked up. If other pieces below it are also picked up, carefully prise them off with a screwdriver before lifting the load any higher.  
**Do not attempt to pull them off by hand, since your fingers may be trapped!**



Danger

### 8.3 Lowering Loads

- Lower the load on to a flat surface which is free of obstacles, so that it cannot slide away or tip over when released.
- Slide the sleeve of the manual slide valve back towards the red lamp.
- The load is now released.

## 9 Maintenance and care

### 9.1 Maintenance

To ensure the correct function, safety and service life of the device the following points must be executed in the maintenance interval.



**Take care that for all maintenance services the device is completely shut down!!**

#### MECHANICAL

##### Service interval

**First inspection after  
25 operating hours**

**After 50 operating hours**

**Minimum 1x per year  
(at rough conditions  
shorten the interval)**

##### Maintenance work

- Control and tighten all screws and connection.  
(The implementation is only allowed by an expert).
- Tighten all screws and connection (Take care that the tightening torques according to the property class of the screws are observed).
- Check all joints, bolts, guidance's and gears for correct function, if necessary adjust or replace it.
- Check all Grippers ( if available) for signs of wear.
- Grease all slidings ( if available) when the device is in opened position with a spatula.
- Check of all the suspension parts, bolts and straps. Check for corrosion and safety by an expert.

### 9.2 General Notes

**The vacuum pumps may not be opened during the warranty period, since this will invalidate the warranty!**

### 9.3 Maintenance Plan

	Interval				
	Daily	Weekly	Monthly	Every 6 months	Every 12 months
Check the safety devices: - vacuum gauge OK?	X				X
Inspect the filter		X			X
Electrical equipment OK? Cable glands tight?					X
Check the state of charge of the battery	X				X
Drain off condensation		X	X		
Are the vacuum hoses in good condition (not brittle, not kinked, no abrasion, no leaks)?			X		X
Are all connections and hose clamps tight.?				X	
Are the brief operating instructions, the rating plate and the load plate still attached to the device?					X
Are the Operating Instructions still available and are the users familiar with them?					X
Inspect supporting elements (crane beam, etc.) for deformation, wear and other damage.					x
Clean and inspect the suction plates (no cracks, sealing lip free of damage, etc.) and replace as necessary		X			X
Is the inspection certificate up to date?					X
General condition of the device					X
Leak test			X		X

### 9.4 Suction Plates and Sealing Lips

Clean the sealing lips with glycerine once per week to remove any objects or dirt such as glue, wood chips, dust etc.

Damaged or worn sealing lips (cracks, holes, deformation) must be replaced immediately.

Use only cold solvent for cleaning the device. Do not use benzene or caustic liquids, since these will damage the hoses.

## **9.5 Filter**

Inspect the paper filter at least once per week.

If it is very dirty, replace it.

Procedure:

- Open the cover of the lifting device.
- Loosen the hose clamp and take out the filter.
- Install the new filter and secure it with the hose clamp.
- Close the cover of the lifting device.

## **9.6 Draining Condensation**

During vacuum generation, the moisture in the air is condensed into water.

**This condensation must be drained off at least once per week.**

To do this, open the drain cock on the device and allow the water to run out.

Then close the drain cock again

Drain cock for  
condensation



## 9.7 Changing the Battery

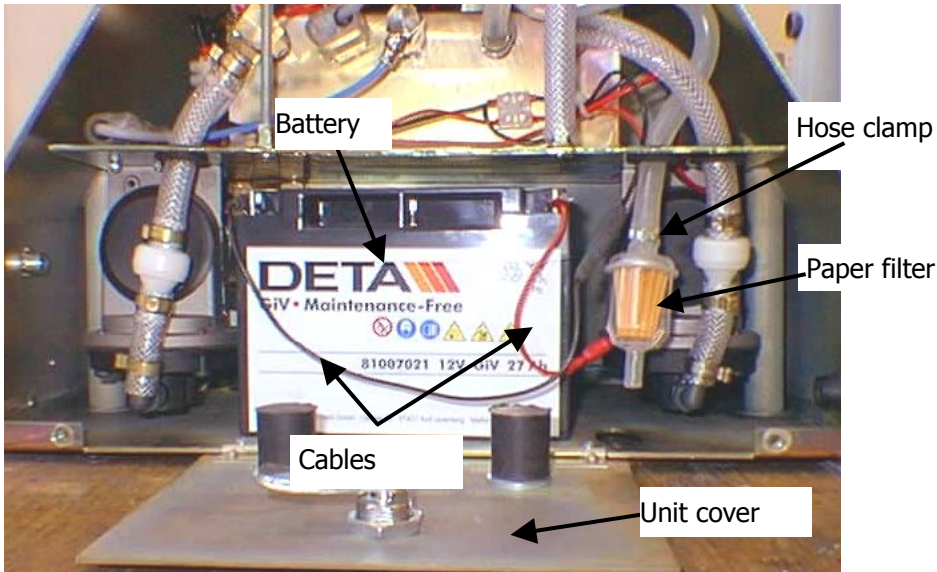

### Procedure

- Switch off the lifting device.
- Open the cover.
- Disconnect the power cables and remove the battery.
- Install the new battery and connect the power cables to it. Connect the cables with the correct polarity (red to red and black to black).
- Close the cover again.

## 9.8 Repairs

- Only persons with the appropriate knowledge and ability are allowed to repair the device
- Before the device is used again, it has to be checked by an expert.



**For all repairs the device must be completely shut down!**

## 9.9 Troubleshooting

<b>Problem</b>	<b>Cause</b>	<b>Remedy</b>
Pump does not run.	Battery discharged or defective	Charge or replace the battery
	Vacuum pump defective	Check the pump, call customer service
Pump runs but does not evacuate the suction plate.	Filter dirty	Blow out or replace the filter
	Manual slide valve is set to "Release" (towards red lamp)	Move manual slide valve to "Grip" (away from the red lamp)
Vacuum does not reach -0.58 bar.	Load is cracked, has apertures or is porous	This load is not suitable for lifting with the device
	Sealing lip of suction plate is damaged	Replace the sealing lip
	Vacuum gauge is faulty	Replace the vacuum gauge
	Hoses or connections are leaking	Replace any defective components
Vacuum reaches -0.58 bar but the load is not gripper	Manual slide valve is faulty	Repair or replace the valve
Red lamp flashes	The vacuum is less than -0.58 bar	If necessary, activate the second pump; otherwise, see the above problems



### 9.10 Safety procedures

- It is the contractors responsibility to ensure that the device is checked by an expert in periods of max. 1 year and all recognized errors are removed.
- We recommend, that after checking the device the badge „Safety checked“ is put on the device.  
(Order-No.: 2904.0056)
- The corresponding regulations of the declaration of conformity have to be observed!
- You can receive these badges from us.



**The check by an expert must be proved!**

Device	Year	Date	Expert	Company
	2004			
	2005			
	2006			
	2007			
	2008			
	2009			
	2010			
	2011			

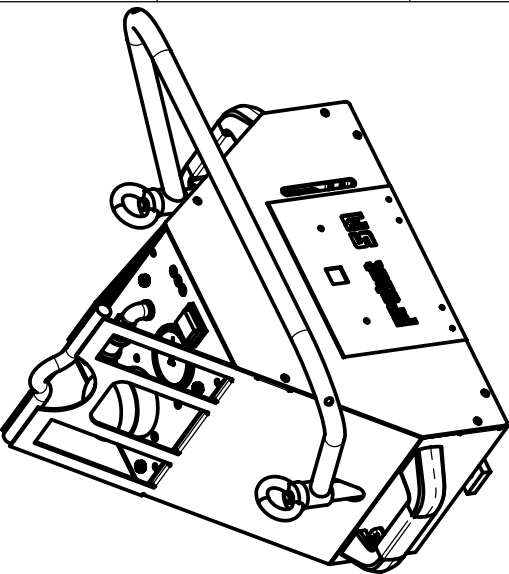
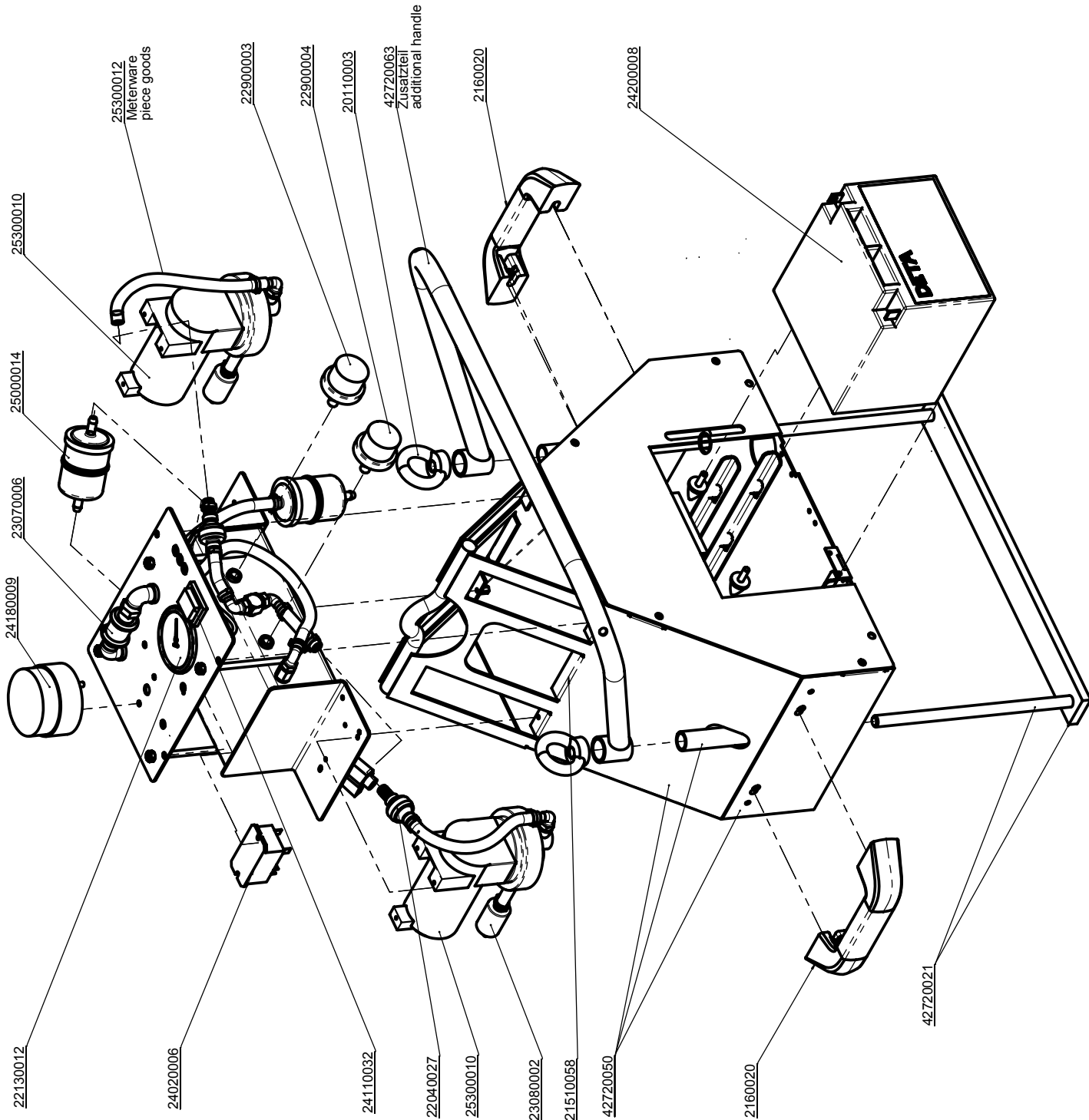

Bei Änderungen Rücksprache TB !

Gewicht: 63,1 kg

Schutzvermerk nach DIN 34 beachten!  
Nachdruck nur mit unserer Genehmigung!

Bewerbung  
Vakuum-Stein-Magnet SM  
Grundeinheit

Artikelnummer/Zachnungsnummer  
E52720002

Datum	Name
Erst: 30.4.2004	pernival hurth
Gepr.	
WA:	
Konrad:	
Zust. Urspr.	

Blatt 1 von 1

Ers. f. Ers. d.



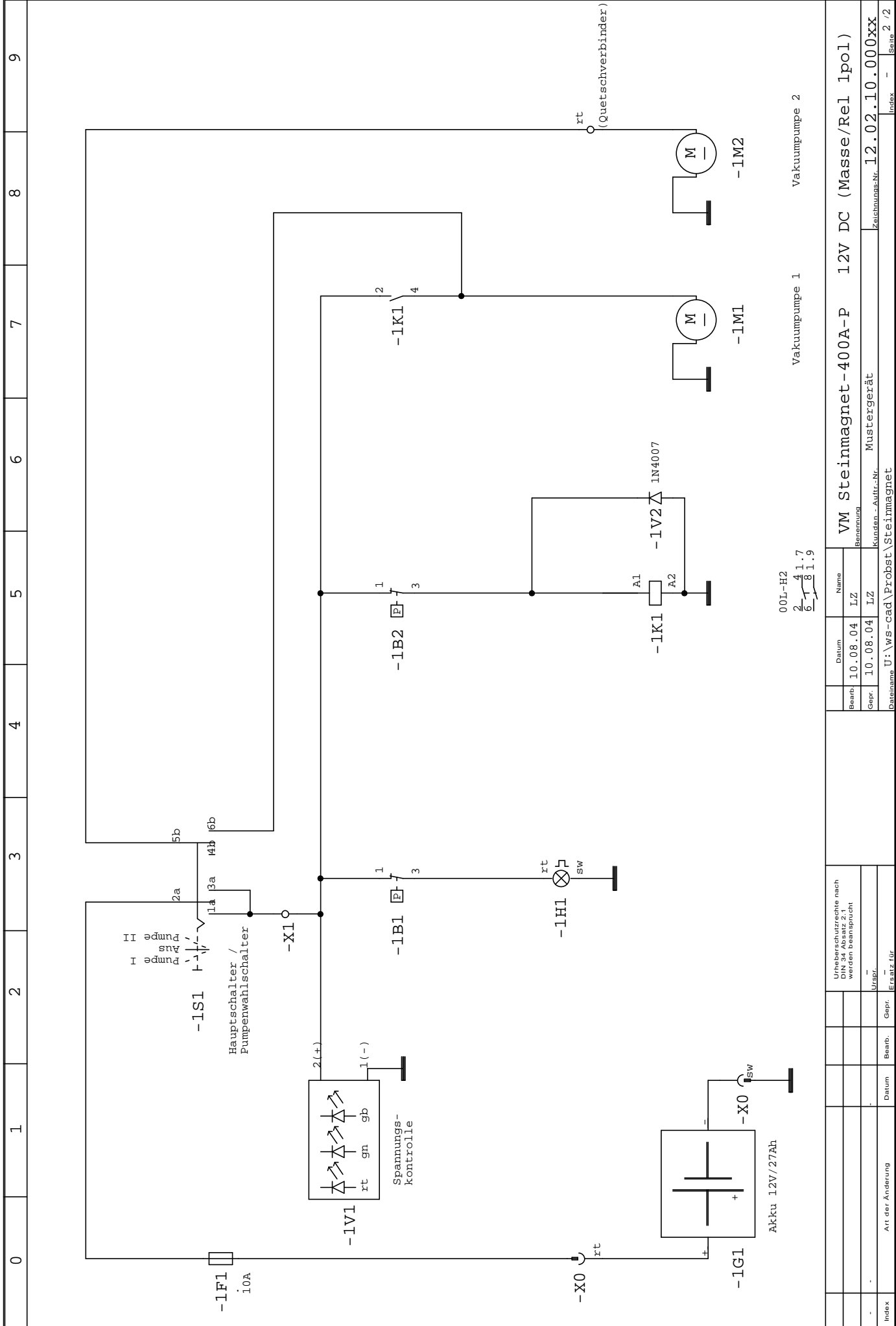

00L-H2  
 2  
 4  
 1.7  
 6  
 1.9

Vakuumpumpe 1

Vakuumpumpe 2

Index	Art der Änderung	Datum	Bearb.	Gepr.	Erstz. für	Urheberrechte nach DIN 34 Absatz 2.1 werden beansprucht	Benennung	Name	ILZ	ILZ	ILZ	Index
-	-	-	-	-	-	-	VM Steinmagnet-400A-P	12V DC (Masse/Rel. 1pol)				
-	-	-	-	-	-	-	Mustergerät					
-	-	-	-	-	-	-	Kunden - Aufl.-Nr.					
-	-	-	-	-	-	-	Zeichnungs-Nr.					
-	-	-	-	-	-	-	12.02.10.000xx					
-	-	-	-	-	-	-	Index					
-	-	-	-	-	-	-	Seite					
-	-	-	-	-	-	-	2 / 2					

# Stone Magnet (SM) - Spare Parts Vacuum Pump

## DRAWING AND PARTS LIST

Item No.	Part No.	Description	Qty
1	667153	Motor Shell & Magnets	1
2	608815	Diaphragm	1
3	615764	Shim	1
4	621559	Diaphragm Hold down Plate	1
5	625363	Screw - Hold down Plate	4
6	625737	Screw - Eccentric	1
7	607555	Conn. rod, Bearing & eccentric Assembly	1
8	664258	Housing	1
9	614809	Motor End Cap	1
10	625552	Screw - Housing to Motor (#8.32x4")	2
11	626503	Lockwasher	2
12	625646	Screw - Head Assembly to Housing	4
13	664391	Head Plate Assembly	1
14	638101	Plug - Snap-In	1
15	618131	Tubing - Insulator	2

007CDC13			
Item	Delete	Add	Description
3	615764	-----	Shim
4	621559	621562	Hold Down Plate
7	607555	607554	Conn.Rod, Bearing & Eccentric Ass'y.
13	669391	664398	Head Plate Assembly

007CDC13 007CDC19/24			
Item	Delete	Add	Description
4	621599	621562	Hold Down Plate
13	664391	664398	Head Plate Assembly

